

# MRL Passenger Elevator

## Hoistway Structure

Concrete  Brick & Concrete  Other

Unstandard  Standard

NOTE

Technical Requirement:

|         |  |     |                     |            |                         |           |                       |
|---------|--|-----|---------------------|------------|-------------------------|-----------|-----------------------|
| HW      | HOISTWAY WIDTH                             | CW  | CAR INSIDE WIDTH    | Type       | TKJW 1000 / 1.0 -VF     |           |                       |
| HD      | HOISTWAY DEPTH                             | CD  | CAR INSIDE DEPTH    | F/P/D      | /                       | /         | Door type Center open |
| OP      | DOOR OPENING WIDTH                         | CH  | CAR HEIGHT          | load       | 1000                    | kg        | speed 1.0 m/s         |
| ROP     | WALL OPENING WIDTH                         | MRW | MACHINE ROOM WIDTH  | Machine    | MONA 320                | Roping    | 2:1                   |
| OPH     | DOOR OPENING HEIGHT                        | MRD | MACHINE ROOM DEPTH  | T/sheave   | ∅ 320                   | D/sheave  | ∅                     |
| OH      | OVERHEAD HEIGHT                            | MRH | MACHINE ROOM HEIGHT | car sheave | ∅ 320                   | CW sheave | ∅ 320                 |
| CAR DBG | DISTANCE BETWEEN CAR GUIDE RAILS           |     |                     | Shaft      | HW 2150 mm x HD 2150 mm |           |                       |
| CWT DBG | DISTANCE BETWEEN COUNTERWEIGHT GUIDE RAILS |     |                     | Cabin      | CW 1400 mm x CD 1600 mm |           |                       |
|         |  |     |                     | Door       | OP 900 mm x OPH 2100 mm |           |                       |

Compact type

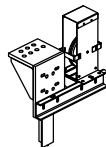

Speed limiter base detail

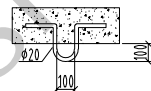

The hook

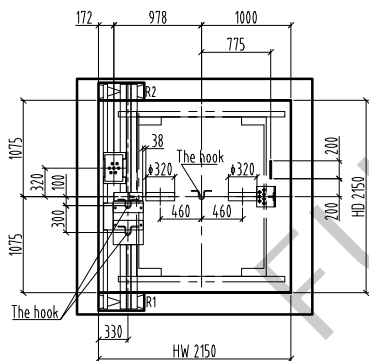

Overhead plan/1:60

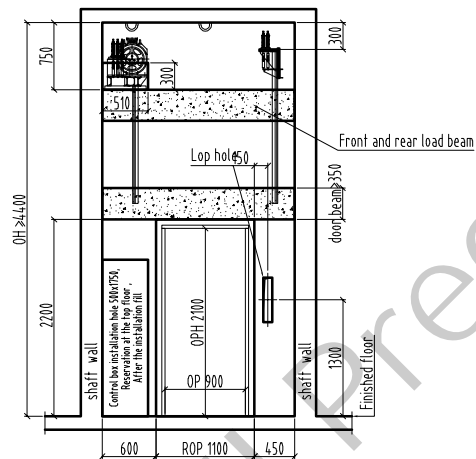

E/reserved hole/1: 60

The other side door hole is symmetrically reserved according to E to the door hole

Bottom box Lop: 100x500 (base station) 100x400 (remaining stations)  
No bottom box Lop hole: ∅50 hole

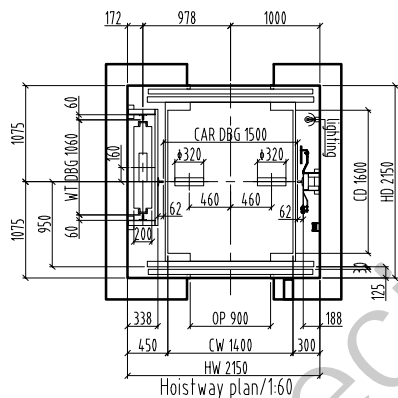

Hoistway plan/1:60

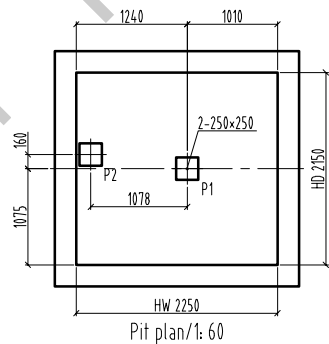

Pit plan/1: 60

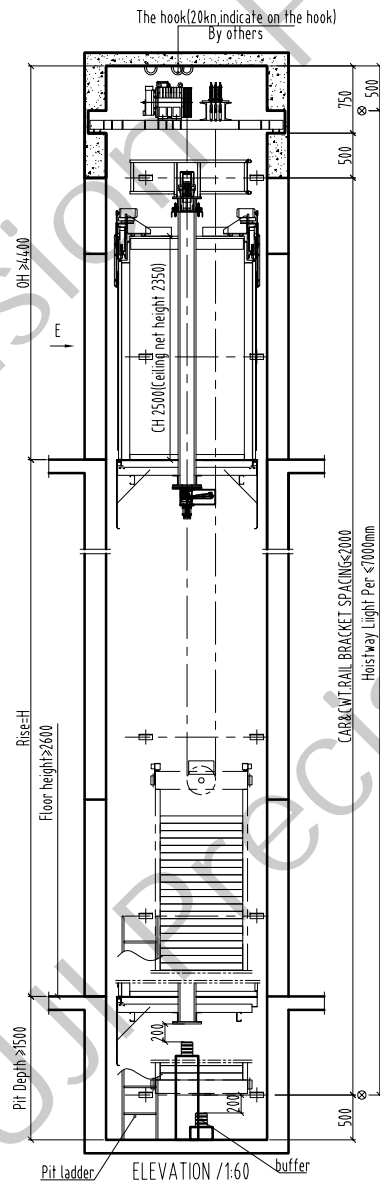

The hook(20kg indicate on the hook)  
By others

|         |       |       |       |       |
|---------|-------|-------|-------|-------|
| Speed   | 1.0   | 1.5   | 1.75  | (m/s) |
| Power   | 6.7   | 10.1  | 11.8  | (kw)  |
| OH      | ≥4400 | ≥4500 | ≥4600 | (mm)  |
| Pit     | ≥1500 | ≥1600 | ≥1700 | (mm)  |
| current |       |       |       | (A)   |

380V 3phase 5wire, 50Hz, fluctuation ±7%

Support Force (N)

|       |       |    |    |       |       |    |    |
|-------|-------|----|----|-------|-------|----|----|
| R1    | R2    | R3 | R4 | P1    | P2    | P3 | P4 |
| 31400 | 39600 |    |    | 88000 | 68000 |    |    |

Technical Requirement

1. Power supply: machine room need equiped with power supply. Power supply box need be locked. Power supply should be 3P.5 wires, 380V 50Hz. Voltage tolerance ±7%, input power more than 50% of motor power, also equiped with air switch same capacity with power supply, also allow the supplement leakage protector. When use VVVF, need use special leakage switch. Ground resistor should be < 4Ω. It should use insulated conductor from floor to machine room. Keep separate for null wire and ground wire.

2. Shaft requirement, it should be only for lift, can not install non-related device (pipe, cable, etc), and should keep the person entrance into. The shaft plan size mean the min size measured by plumb line, tolerance ±50mm. Basically not allow the protruding beam and column. The proof pressure of shaft side should be > 24MPa. Recommend to use full concrete, can not use the reserved steel. In case use solid brick, it should use reserved steel or make the ring beam on the surface of reserved steel, height > 300mm. If use hollow brick, can choose C25 concrete fill into the wall, also make the ring beam on the surface of reserved steel, height > 300mm. If the shaft front wall is brick construction, it should make the concrete beam up side of door hole to fix the landing door bracket, height > 300mm. If have the requirement in the drawing, it should make the concrete in the entrance of hall door. It should equiped with lamp, brightness > 50LX, install the lamp at 0.5m from the top and the bottom, in the middle, each lamp at < 1.5m. The buffer block should be made accompany with special person. Before that need make the reserved 240x25 joint bar, > 12mm, height > 500mm from the pit floor, and should water proof. Keep the space for person entrance. Pit ladder is by user. Should installed it in a suitable place. If there have basement downside of the pit should make the buffer block extend to the solid floor downside. If the floor distance between 2 floor > 1m, should set the safe door with the width 350mm, height 1800mm.

3. Machine room requirement (not for MRL). It had the passageway for the traction machine. keep the entrance unblocked. the door opens outward, also can be locked. Installed the fan, keep the humidity < 85%, temperature +5C-40C, surrounding the reserved hole should make the 50mm hole, keep the floor plan, also bear the load 700kg/m<sup>2</sup>. The net or beam should be supported in the concrete block, this concrete block should extend to the building beam or bearing wall. Bearing side should make the reserved same side steel, thickness 2mm, bearing side thickness should over the wall thickness 20mm, total thickness more than 75mm. Standard wall 200mm, recommend the bearing wall thickness > 200mm. The hook in the machine room should indicate the max. load. It should install the ladder and barrier in case have stair.

|       |        |
|-------|--------|
| OH    | ≥4400  |
| Rise  | H      |
| 26 F  |        |
| 25 F  |        |
| 24 F  |        |
| 23 F  |        |
| 22 F  |        |
| 21 F  |        |
| 20 F  |        |
| 19 F  |        |
| 18 F  |        |
| 17 F  |        |
| 16 F  |        |
| 15 F  |        |
| 14 F  |        |
| 13 F  |        |
| 12 F  |        |
| 11 F  |        |
| 10 F  |        |
| 9 F   |        |
| 8 F   |        |
| 7 F   |        |
| 6 F   |        |
| 5 F   |        |
| 4 F   |        |
| 3 F   |        |
| 2 F   |        |
| 1 F   |        |
| G F   |        |
| B F   |        |
| Pit   | ≥1500  |
| Floor | Height |

4. Drawing

|                   |                 |
|-------------------|-----------------|
| Drawing           | approver        |
| Drawing No.       | FTKW 1000 -04 - |
| manufacturing no. |                 |
| Project name      |                 |

FUJI PRECISION